

**SUNON®**  
**POWERFUL HVLS FAN**  
**SERIES 1**

Installation Manual



# Caution & Safety

**WARNING – TO REDUCE THE RISK OF ELECTRIC SHOCK OR INJURY TO PERSONS, OBSERVE THE FOLLOWING :**

1. Installation work and electrical wiring must be done by qualified person(s) in accordance with all applicable codes and standards.
2. Do not damage existing wiring and other hidden utilities/devices when cutting or drilling into a wall or ceiling.
3. Use this unit only in the manner intended by the manufacturer. If you have questions, contact the manufacturer.
4. Mounting of the suspension system and replacement of parts of the safety suspension system shall be performed by the manufacturer, its service agent, or suitably qualified persons.
5. Do not operate any fan with a damaged cord or plug. Please contact manufacturer and qualified technician for examination and/or repair.
6. Before servicing or cleaning unit, turn off all the power switches to prevent power from being switched on accidentally. When the circuit breaker cannot be locked, securely fasten a prominent warning device, such as a tag, to the service panel.
7. SUNON provides installation guide for mounting fans; however, it is the sole responsibility of the building owner and installer to ensure the safety of the mounting system, that the building structure is sound and that the installation complies with all federal, state, and local codes.
8. While turning on power to the fan, please use it with caution. DO NOT connect the fan to a damaged/dangerous power source. DO NOT attempt to resolve electrical problems by yourself. Please SEND the fan back to authorized service center for examination and/or repair. If there is any question with installation, please contact customer service.
9. When service or replacement of a fan component requires the removal or disconnection of a safety device, the safety device is to be reinstalled or remounted as previously installed.
10. Do not bend the airfoils when installing, servicing, or cleaning the fan. Do not insert foreign objects between rotating airfoils.
11. This appliance is suitable for use in countries and regions with hot and humid climates but can also be used in other countries and regions.
12. (for EU region) This appliance can be used by children aged from 8 years and above and persons with reduced physical, sensory or mental capabilities or lack of experience and knowledge if they have been given supervision or instruction concerning use of the appliance in a safe way and understand the hazards involved.
13. (for EU region) Children shall not play with the appliance.
14. (for EU region) Cleaning and user maintenance shall not be made by children without supervision.
15. (for other than EU region) The appliance is not to be used by persons (including children) with reduced physical, sensory or mental capabilities or lack of experience and knowledge, unless they have been given

supervision or instruction.

16. (for other than EU region) Children being supervised not to play with the appliance.
17. SUNON Fans product warranty will not cover equipment damage or failure that is caused by improper installation or use.
18. If unusual oscillating movement is observed, immediately stop using the ceiling fan and contact the manufacturer, its service agent, or suitably qualified persons.
19. Powerful HVLS Fan controller is equipped with a memory function. After disconnecting power, it still remembers the previous operation mode. Once turning on power to the fan, it also keeps previous operation mode.
20. Please use this unit only the manners specified by the company. Please contact customer service if you have questions.

## **Thank you for purchasing SUNON products!**

Please read this manual carefully before use, use the product accordingly and keep the manual in safe place.

In order to protect your rights and interests, please make sure that the dealer records the purchase date, dealer's name, etc. on the guarantee.

# Table of Contents

	<b>Introduction</b>
Page	
5	Fan Outline
6	Product Specifications
7	Installation Precautions
8	• The Placement & Clearance between Fan and Obstructions
8	• The Placement & Clearance between Fan and HVAC Diffuser
	<b>Pre-Installation</b>
Page	
9	Inside the box
10	Tools Required for Installation
10	Fan Diagram
11	Pre-Installation Checklist
	<b>Installing the Fan</b>
Page	
12	Installation Method
16	Fan Connection
	• Warning
	• Power Requirements
	• Wiring Codes
16	Wiring Diagram
17	RF Remote Control
	<b>Information</b>
Page	
18	Troubleshooting
18	General Troubleshooting
19	Maintenance
20	Warranty

## Introduction

Thanks for choosing our products, Powerful HVLS Fan is an efficient, economical and stylish choice. It's energy-saving, eco-friendly design brings excellent airflow to space. We assure you this appliance will make your space cozier and occupant comfort in the near future.

## Fan Outline

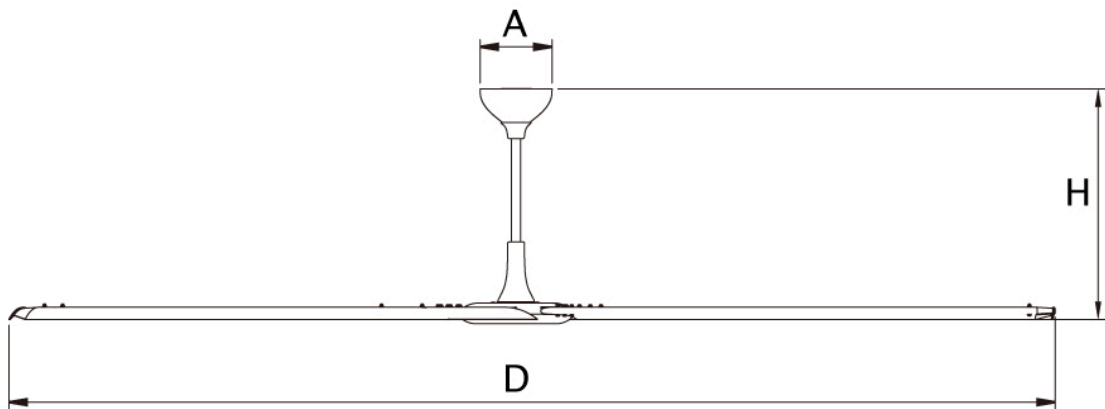

D	H	A
5 ft / 1.5 m	1.7 ft / 525 mm	0.65 ft / 200 mm
6.5 ft / 2.0 m		
8 ft / 2.5 m		
10 ft / 3.0 m		

# Product Specifications

## Powerful HVLS Fan Series 1 – 5 ft (1.5 m)

Input Voltage (VAC)	Input Frequency (Hz)	Maximum Rated Power (W)	Maximum Rated Current (A)	Maximum RPM (RPM)	Noise (dB(A))
220-240	50/60	54	0.47	180	<35

## Powerful HVLS Fan Series 1 – 6.5 ft (2 m)

Input Voltage (VAC)	Input Frequency (Hz)	Maximum Rated Power (W)	Maximum Rated Current (A)	Maximum RPM (RPM)	Noise (dB(A))
220-240	50/60	72	0.6	130	<35

## Powerful HVLS Fan Series 1 – 8 ft (2.5 m)

Input Voltage (VAC)	Input Frequency (Hz)	Maximum Rated Power (W)	Maximum Rated Current (A)	Maximum RPM (RPM)	Noise (dB(A))
220-240	50/60	84	0.71	95	<35

## Powerful HVLS Fan Series 1 – 10 ft (3 m)

Input Voltage (VAC)	Input Frequency (Hz)	Maximum Rated Power (W)	Maximum Rated Current (A)	Maximum RPM (RPM)	Noise (dB(A))
220-240	50/60	84	0.71	70	<35



## Installation Precautions

1. This HVLS fan need a proper device which can support its weight such as aerial work platform and at least two installation persons.
2. Please switch off all the power supply before installation to avoid the risk of electric shock or lighting shock.
3. All wiring construction must comply with the national electrical codes, standards and the local electrical law, then must be installed by professional technicians or personnel.
4. An earth leakage circuit breaker (<30 mA) should be installed between the appliance and the power switch.
5. The power switch must be fitted with a fuse ( $\geq 20$  A).
6. The yoke must be securely mounted to the ceiling or beam.
7. Do not damage electrical wiring and other hidden utilities/devices when installation.
8. To avoid fire or other hazards, make sure that the wires are completely inside, no any wire exposed outside the fan appearance or other parts.
9. Do not bend the airfoils when installing the fan.
10. The HVLS fan model covered by the installation instructions must comply with this installation manual and all national/local electrical codes to avoid personal injury or property damage.
11. Please ensure that this application is equipped with AC single phase 220–240 V before installation.
12. All fan parts must be  $\geq 2$  ft (0.6 m) from all obstructions. The fan installation area must be free of obstructions such as lights, cables, sprinklers, or other building structure components.
13. The distance should be at least 1.6 ft (0.5 m) from the top of the winglet to the ceiling and no obstructions in this area.
14. The fan must be installed so that it is at least 10 ft (3.05 m) above the finished floor.
15. Multiple fans must be spaced at a center-to-center distance that is no less than 2.5x the fan diameter.
16. The fan should not be located near to air supply outlets or exhausting inlets of other HVAC equipment. Air supply outlets/inlets can be configured to deliver air away from the fan and outside the swept area of the fan.
17. If the fan is mounted at the same level or higher than an HVAC diffuser, the winglets must be at a distance that is at least 1.5x the measure of the fan's diameter. If the fan is mounted below an HVAC diffuser, the winglets must be at a distance that is at least 2x the measure of the fan's diameter.
18. Pleases see the manufacturer's requirements for the minimum clearance to combustibles.
19. The fan inlet or other return air point that produces negative pressure should be bigger than 1 times the diameter of the ceiling fan. This system will reduce the airflow of the HVLS fan.
20. Proper systems orientation will provide an enhancement to the Indoor Air Quality and occupant comfort. Please refer to the illustration below.

## The Placement & Clearance between Fan and Obstructions

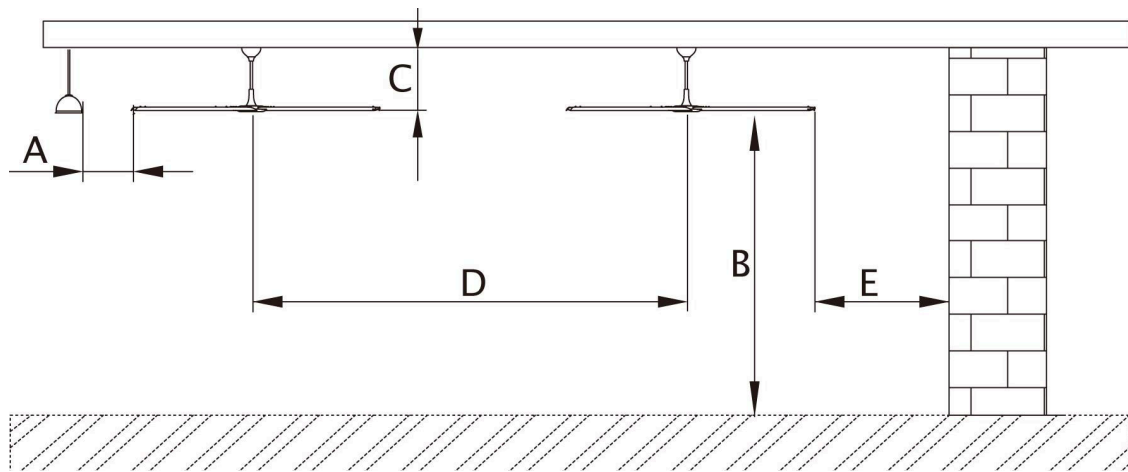

- A- The tip of airfoil need at least 2 ft (0.6 m) away from light or any equipment and no obstacles.
- B- The Ceiling fan need at least 10 ft (3.05 m) away from floor.
- C- The tip of the airfoil need at least 1.6 ft (0.5 m) away from beam / ceiling and no obstacles.
- D- Spacing between fans at least 2.5x diameter of the fans apart.
- E- Space from wall at least 2 ft (0.6 m) away from the wall.

## The Placement & Clearance between Fan and HVAC Diffuser

- The HVLS fan position need to above the HVAC outlet

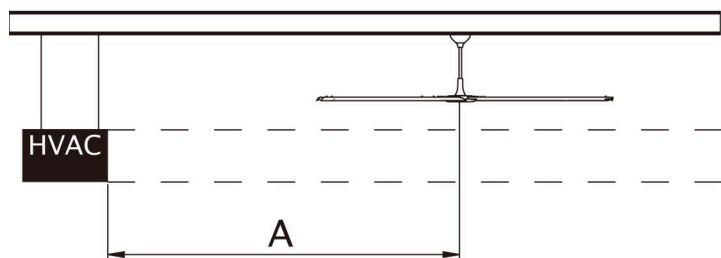

A: The distance between the center of the ceiling fan and HVAC equipment need to at least 1.5x diameter.



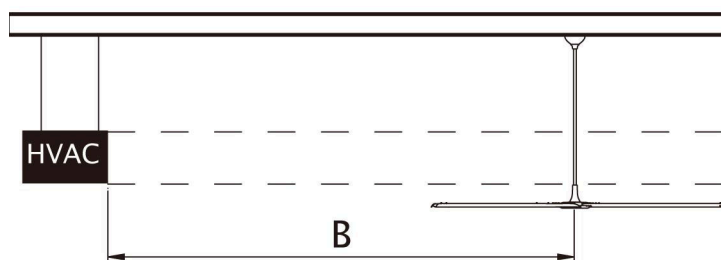







- The HVLS fan position need to below the HVAC outlet

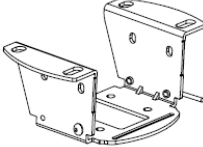

B: The distance between the center of the ceiling fan and HVAC equipment need to at least 2x diameter.

# Inside the box

## Main Box

		
Motor Unit*1	Fixed Bracket*1	Yoke*1
		
Extension Tube Unit*1	Canopy*1	Circuit Box Unit*1
 	 6	 21 21 21
Remote Control *1	Closed-End Wire Connector*6	Airfoil Kit (M6 30L Bolt Kit)

## Airfoil Box

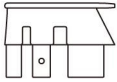
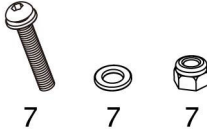
	
Airfoil*7	
	 7 7 7
Winglet*7	Winglet Kit (M6 30L Bolt Kit)

## Tools Required for Installation

Yoke Installation	Mechanical Installation	Electrical Installation
<ul style="list-style-type: none"> <li>Secure the yoke to the mounting structure with suitable hardware (We recommend M6 bolt kits)</li> </ul>	<ul style="list-style-type: none"> <li>Guy wire cutter</li> <li>Torque wrench 4.9 -24.51 N.m (50-250 Kgf.cm) for inspection purpose</li> <li>Standard Allen wrench set</li> <li>Standard wrench/socket set</li> <li>Electronic level</li> </ul>	<ul style="list-style-type: none"> <li>Utility Knife</li> <li>Multimeter</li> <li>Crimping Pliers</li> <li>Pair if #10 to #24 AWG strippers</li> <li>Diagonal Pliers</li> </ul>

## Fan Diagram

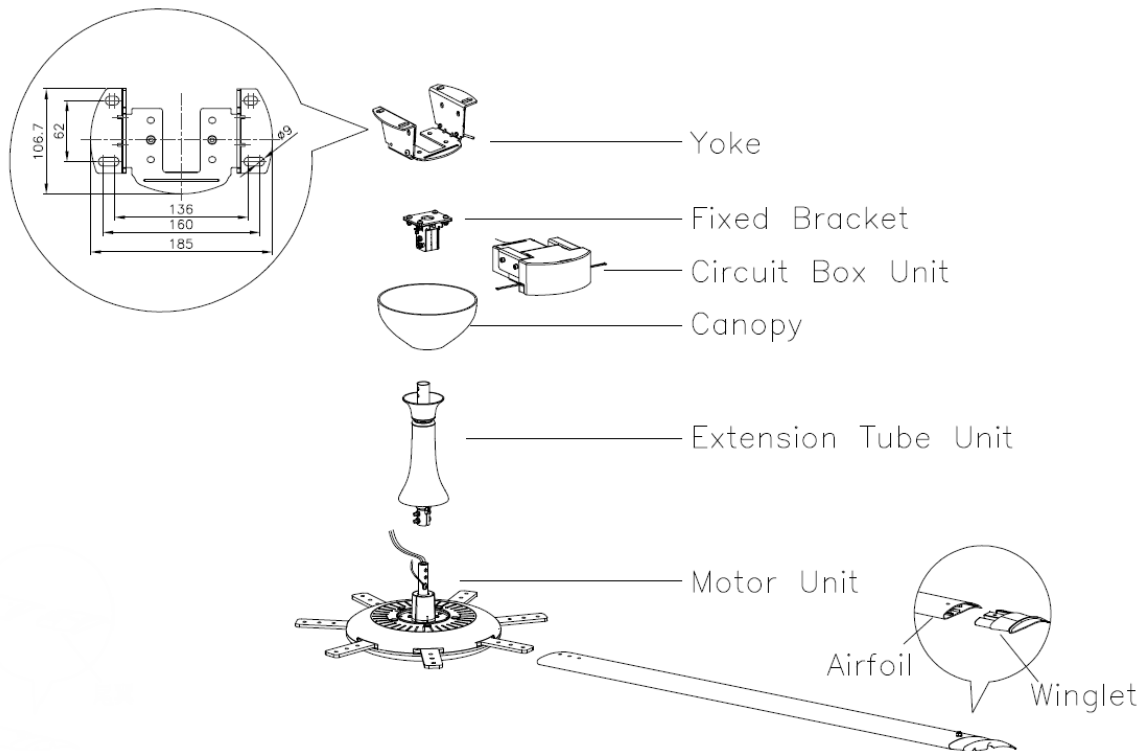

## Pre-Installation Checklist

	<p>Equipped with appropriate mounting kit for roof pitch.</p> <p><b>The fan can only be mounted to the I-beam. DO NOT mount the fan directly to a single stringer, truss shelf or light steel shelf. For installation methods not included in this manual, please consult a structural engineer.</b></p>
	<p>The mounting structure approved by structural engineers.</p> <p>The mounting system must be able to withstand the torque generated by the fan.</p>
	<p>Having been familiar with the functions of the safety cable. °</p>
	<p>For the fan installation, the fan blades should be at least 10 feet (3.05 meters) above the ground. (Please refer to “The Placement &amp; Clearance between Fan and Obstructions ” Page 8)</p>
	<p>For the fan installation, the distance between the blades and other objects/building structure should be at least 2 feet (0.6 meters). (Please refer to “The Placement &amp; Clearance between Fan and Obstructions ” Page 8)</p>
	<p>The center-to-center distance between two fans should be at least 2.5 times the diameter of the fans. (Please refer to “The Placement &amp; Clearance between Fan and Obstructions ” Page 8)</p>
	<p>When installing the fan, make sure the fan is not affected by high winds from HVAC systems or large garage doors. (Please refer to “The Placement &amp; Clearance between Fan and HVAC Diffuser ” Page 8)</p>
	<p>The yoke size should match mounting structure. (Please refer to “Fan Diagram” Page 10)</p>
	<p>The power supply unit complies with the specification of the frequency converter, and the wires pass through the fan installation position. <b>For power requirements, please refer to voltage sticker on the fan.</b></p>
	<p>The airfoil should not be mix up with other airfoil boxes.</p>

## Installation Method

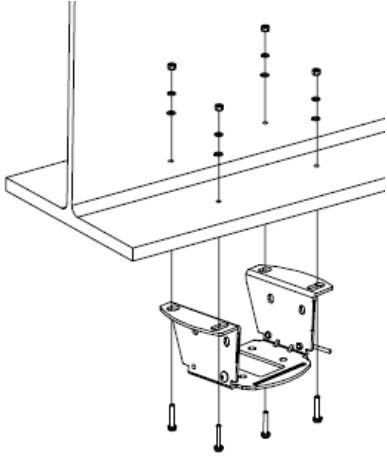
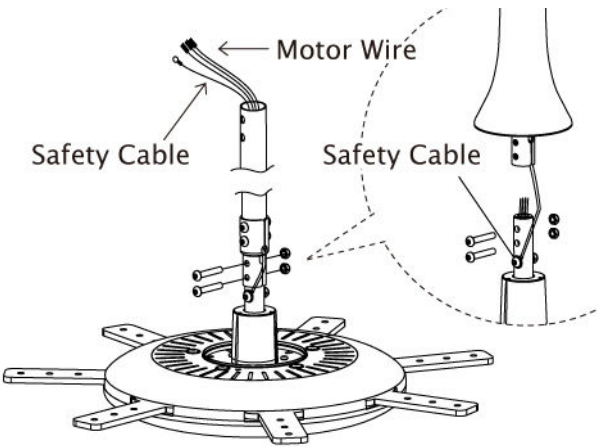
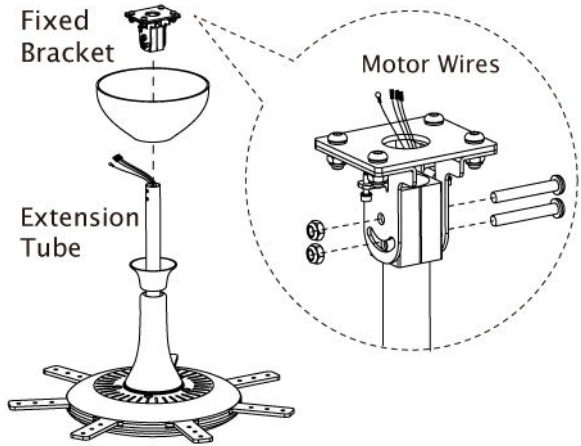
	<p>1-1 Secure yoke to the mounting structure with suitable hardware.  <b>* We recommend M6 bolt kits. °</b></p>
	<p>2-1 Take out the motor unit and the extension tube unit. Loosen the bolt kits of the extension tube unit.                  2-2 Pass through the extension tube unit with motor wire and safety cable.                  2-3 Insert the shaft of the motor between two extension tube clamps, then secure the safety cable and two extension tube clamps with the shaft.  <b>*Recommended Tightening Torque: 5 N.m (50 Kgf.cm)</b></p>
	<p>3-1 Take out the canopy, make the extension tube unit pass through the hole of canopy.                  3-2 Assemble fixed bracket to extension tube unit as shown.  <b>*Recommended Tightening Torque: 5 N.m (50 Kgf.cm)</b></p>

## Installing the Fan

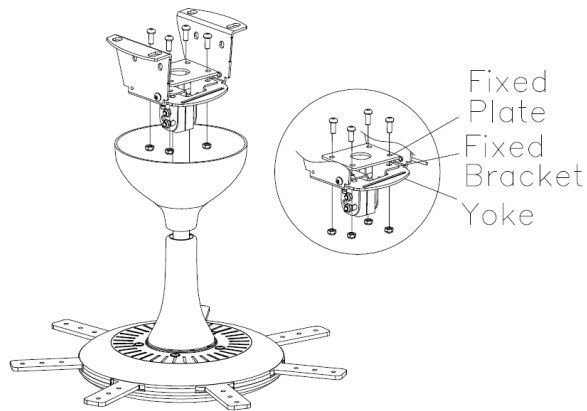

\* Make sure the extension tube unit with the horizon is 90 degrees.

- 4-1 Slide the motor unit into the yoke.
- 4-2 Secure all fixed bracket parts in sequence.

**\*Recommended Tightening Torque:  
5 N.m (50 Kgf.cm)**

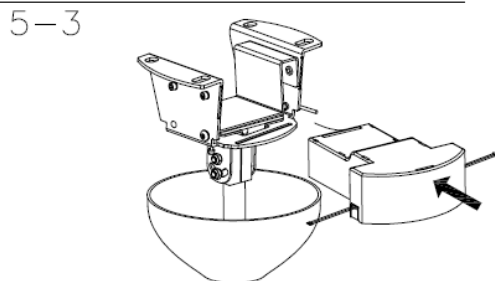
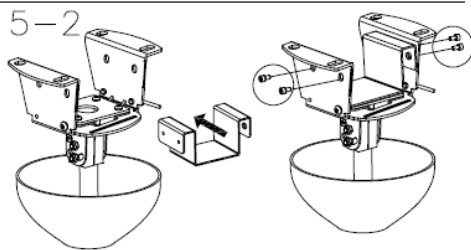
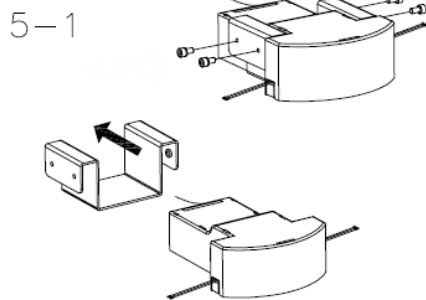

- 5-1 Separate circuit box unit and bracket.
- 5-2 Slide the bracket into yoke then secure it.

**\*Recommended Tightening Torque:  
5 N.m (50 Kgf.cm)**



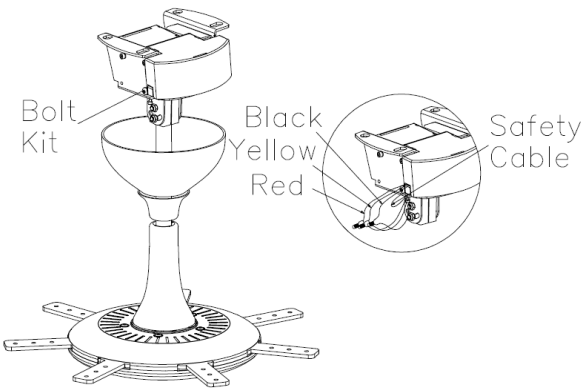
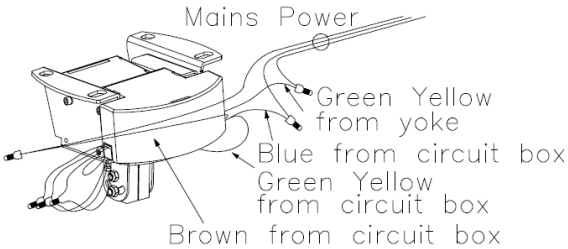
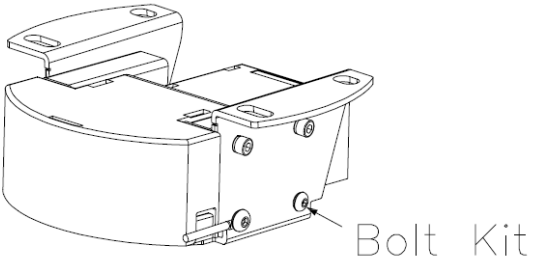

- 5-3 Slide the circuit box into bracket as shown.

## Installing the Fan

 <p>* The antenna must not be entangled with any wires and covered in canopy.</p>	<p>6-1 Use a wire connector to connect the corresponding red/yellow/black wires both from the circuit box and the motor.</p> <p>6-2 Install the safety cable to the yoke with bolt kit.</p> <p><b>*Recommended Tightening Torque: 5 N.m (50 Kgf.cm)</b></p>
 <p>*As shown in the figure, after the wiring is completed, the live wire (L), the neutral wire (N) and the earth wire (E) should be at the both side of the Circuit Box.</p>	<p>7-1 Use a wire connector to connect the indoor wiring with brown/blue wires of the circuit box, as well as the earth wire of yoke as shown. Please refer to “Wiring Diagram” page 16.</p> <ul style="list-style-type: none"> <li>● Live wire : Brown Wire</li> <li>● Neutral wire : Blue Wire</li> <li>● Earth wire : Green Yellow Wire</li> </ul>
	<p>8-1 Loosen and use bolt kit of the yoke. Secure the circuit box's earth wire with the yoke.</p>

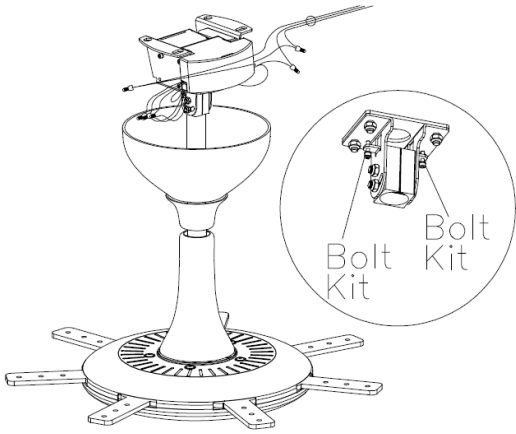
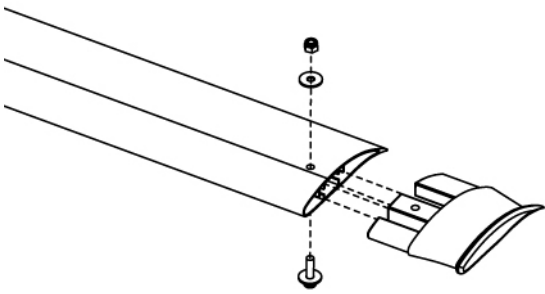

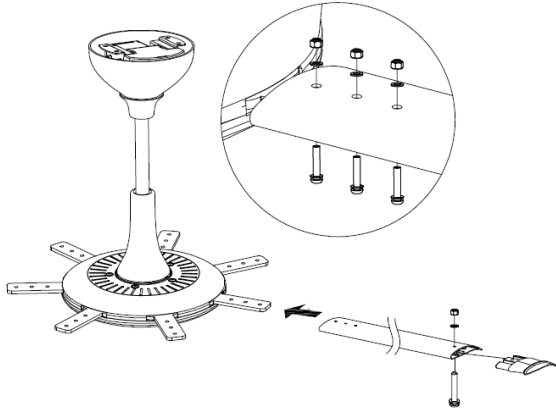
## Installing the Fan

 <p>*Make sure all wires and safety cable are tucked in the canopy.</p>	<p>9-1 Loosen attach bolt kits on fixed bracket, raise the canopy, then secure it to the fixed bracket.</p>
	<p>10-1 Insert the winglet into the airfoil then tighten up. The nut should be secured above the convex side of the airfoil. (Please process this step on the ground.)</p> <p><b>*Recommended Tightening Torque:</b> 5 N.m (50 Kgf.cm)</p> <p>M6 30L 7 Bolt Kit</p>  <p>7      7      7</p>
	<p>11-1 Insert the airfoil into the airfoil strut and tighten with 21 bolt kits as shown.</p> <p><b>*Recommended Tightening Torque:</b> 5 N.m (50 Kgf.cm)</p> <p>M6 30L 21 Bolt Kit</p>  <p>21      21      21</p>

# Fan Connection

## Warning

- To avoid the risk of electric shock, please make sure that the wiring is in good electrical condition and all electricity supply should be disconnected. Above wiring should be implemented by a qualified electrician.
- To avoid the risk of electric shock, please make sure that all wires are insulated properly before the fan is turn on.
- Powerful HVLS Fan warranty will not cover the equipment damage or failure caused by improper installation.
- Powerful HVLS Fan installation should follow national electrical code and standard.

## Power Requirements

This appliance connecting to AC single phase 220–240 V. Please see the voltage sticker on this HVLS fan, avoid any voltage transform in case of danger/damage during installation.

## Wiring Color Codes



	Earth Wire (E or PE)	Live Wire (L or L1)	Neutral Wire (N or L2)
North America	GREEN	BLACK	WHITE
All Other Regions	GREEN YELLOW	BROWN	BLUE

## Wiring Diagram

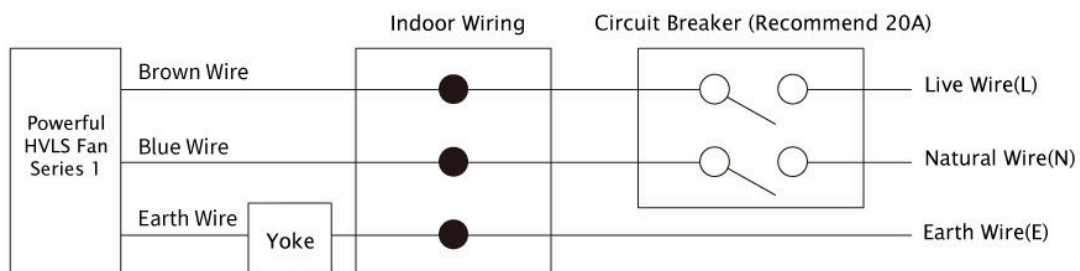
**Caution :** When connecting to indoor wiring, make sure there's an all-pole disconnecting switch as picture shows.

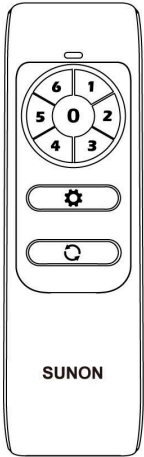

## RF Remote Control

	BUTTON	FUNCTION
	1-6	Press each button to turn on the fan then you can set up the air volume. The number stands for air volume from low to high in numerical order (1 lowest to 6 highest volume). Press each button and the fan will give a short beep, you activate the fan successfully.
	0	Press the button to turn off the fan, it will give a short beep after the fan receives it successfully.
		Press the button to switch the fan direction, it will give 1 beep after the fan receives successfully. Forward: The airflow move downwards. Looking up from the ground the rotation is counterclockwise. Reverse: The airflow move upwards. Looking up from the ground the rotation is clockwise.
	0 + 	Press these two buttons at same time to enter the pairing process. Default is forward. The HVLS fan should rotate counterclockwise when viewed from the ground.
<p><b>Remote Control Pairing</b></p> <ul style="list-style-type: none"> <li>- Make sure the wiring of the ceiling fan is installed by the above instructions.</li> <li>- After turn on the power, it must enter the pairing process in one minute.</li> <li>- Please follow the pairing steps as picture shows.</li> <li>- If you fail to pair, please turn off the power and restart the above process 1 minute later. Please repeat the process if the remote control or the circuit box is changed.</li> </ul> <div data-bbox="644 1182 1369 1350" style="text-align: center;"> <pre>                     graph LR                         A[Power On] --&gt; B["0 + Gear (Press at least 2 seconds)"]                         B --&gt; C[2 Short Beep]                         C --&gt; D[Complete]                     </pre> </div>		
Remark	1. Remote control has paired with circuit box before shipment. 2. Please contact customer service if you want to pair multiple fans per remote control.	

### Battery Installation

- Remove the battery cover and install two AAA batteries.
- Remove the batteries when not used for a long time. Please recycle the used batteries.

### Operation Precautions

1. Make sure the airfoils are standstill before you turn on the fan every time.
2. Press "0" to turn off the fan, DO NOT touch the fan and airfoils once its standstill.
3. Once you press any buttons, the fan will receive the final order and spin direction. DO NOT touch the fan and airfoils during the procedure.

## Troubleshooting

- ▲ **WARNING** – Any fan component replacement, removal or disconnection of a safety devices, all safety device must be reinstalled as formerly setting.
- ▲ **WARNING**– Please use this unit in accordance with the manufacturer’s instructions. If you have any questions, please contact the manufacturer.
- ▲ **WARNING**– Turn the power off before maintaining or cleaning the unit in case of the power from being accidentally switched.

## General Troubleshooting

Issues can be resolved before reaching out the service. Refer to the tips below before contacting Customer Service.

Symptom	Possible Solutions
Abnormal sound from the fan. Airfoil noise occurs when airfoils are not tightened to the specified torque.	Turn off the fan power, and then tighten the airfoil fasteners to 5 N.m (50 Kgf.cm). If the abnormal sound still occurs, please confirm if the airfoils are not contacting each other. If they are, please contact customer service.
The fan is standstill.	Verify the following : <ol style="list-style-type: none"> <li>1. Power supply is fully functional.</li> <li>2. Press the remote control, make sure all buttons and light signals are functional.</li> <li>3. Verify the 2 short beeps after the power set-up is functional.</li> <li>4. Please make sure if the pairing of the remote control is successful.</li> </ol> If the fan still does not start, please contact customer service.

## Maintenance

**WARNING – TO REDUCE THE RISK OF FIRE, ELECTRIC SHOCK, OR INJURY TO PERSONS, OBSERVE THE FOLLOWING:**

1. Turn the power off before maintaining or cleaning unit in case the power from being electrical shock.
2. Any fan component replacement, removal or disconnection of a safety device, all safety devices must be reinstalled as formerly setting.
3. Please schedule an annual maintenance to ensure the fan's safety and efficient operation.
4. Ensure the fan spin direction is proper, the ceiling fan should rotate in a counterclockwise direction (View from the ground).
5. Please use a gentle cleaner or degreasing agent when dusting the motor. DO NOT use chlorine-based cleaning products in case of toxic/fatal fumes exposure.
6. Check all the connections such as safety cables, mounting parts is tighten. Also make sure the mounting system is securely tighten. Any wobbling problems should not happen when you switch on the fan. If any wobbling problem is noticed, make sure the mounting structure is strong enough to support the fan and the wire, make sure you used and tighten your wires, if the wires were not installed, SUNON suggests you to do the wire installation, please contact the customer service if wobbling persists.
7. If the bolt kits are loosened during maintenance, please re-apply the anaerobic adhesive.
8. If you have any questions, please contact Customer Service.

**WARNING – Please DON'T use the damaged or lacking fan components, please contact Customer Service.**

## Warranty

Purchase Date	DD	MM	YY
Serial Number			
Retailer's Stamp	<p>We offer 1 year warranty of our product starting from your purchase date.</p> <p>The following scenarios are excluded from our warranty service. Repairing request will be accepted, but the customer will be charge for cost and service fee.</p> <ol style="list-style-type: none"> <li>1. Damage of improper installation.</li> <li>2. Damage of retrofit.</li> <li>3. Damage of force majeure: Nature, actions of third parties</li> <li>4. Damage of misuse, abuse, accident.</li> <li>5. Damage of improper transportation.</li> <li>6. The warranty document, purchase date or purchase confirmation (like invoice) from authorized dealer cannot be provided by the customer.</li> </ol>		



Do not dispose of electrical appliances as unsorted municipal waste, use separate collection facilities.

Contact your local government for information regarding the collection systems available.

If electrical appliances are disposed of in landfills or dumps, hazardous substances can leak into the groundwater and get into the food chain, damaging your health and well-being.

When replacing old appliances with new ones, the retailer is legally obligated to take back your old appliance for disposal at least for free of charge.

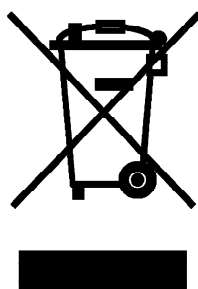

**SUNON®**

Sunonwealth Electric Machine Industry Co., Ltd.  
80673 No. 30, Ln. 296, Xinya Rd., Qianzhen Dist.,  
Kaohsiung City 806, Taiwan (R.O.C.)  
e-mail : sunon@sunon.com  
www.sunon.com

QA Code



20210728 (V1)